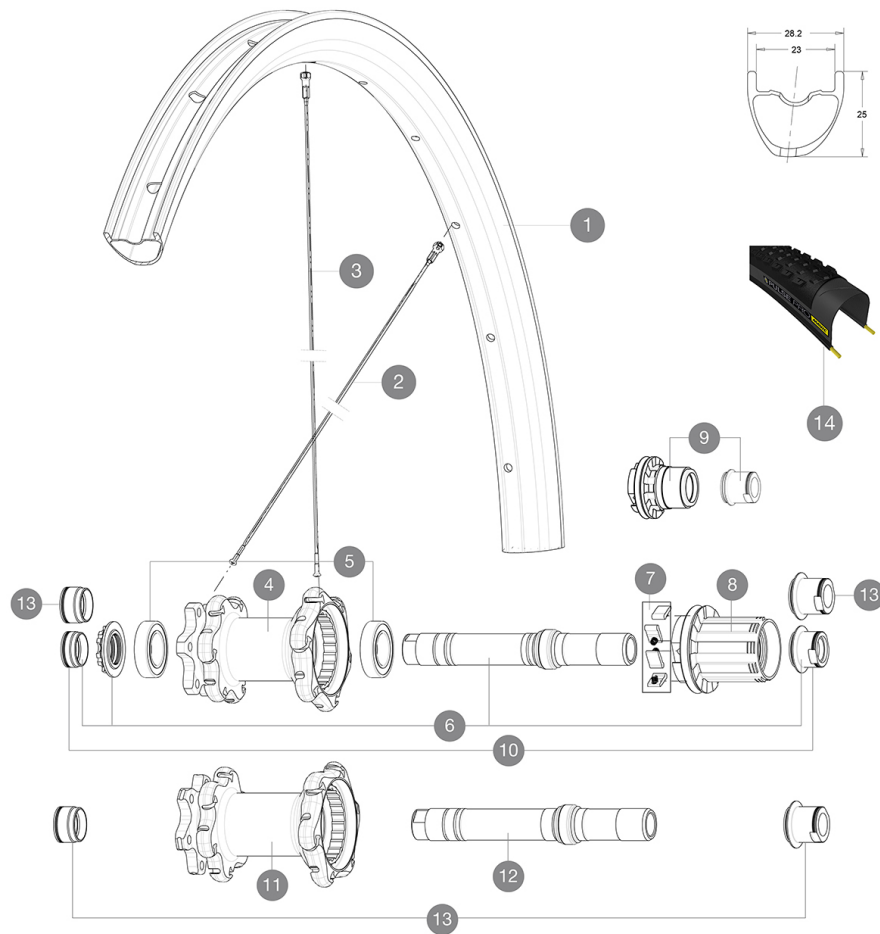

MAVIC **Crossmax Pro Carbon 27.5**

ASTM CATEGORY 3 : offroad with jumps less than 61cm
 Recommended weight limit : 120kg
 Recommended tyre sizes: 28 mm to 62 mm (1.1" to 2.5")
 Recommended tyre sizes: 35 mm to 69 mm (1.4" to 2.7")

REFERENCES WHEELS

P83071	XmaxProCarb27.5PrWTS	R95861	XmProCarb27.5RrXDWTS
R95711	XmProCarb27.5RrBoostWTS B	R81201	XmaxProCarb27.5RrWTS
R95721	XmProCarb27.5RrBoostXDWTS		

**RIMS**

Ø VALVE HOLE (MM): 6,5 :

1	V3270113	SET Rear rim XMAX PRO CARBON 27,5"
---	----------	------------------------------------

SPOKES

2	V2384401	KIT 12 FRONT + REAR NON-DRIVE SIDE BUTTED SPOKES 274mm
3	V2384301	KIT 12 FRONT + REAR DRIVE SIDE BUTTED SPOKES 273mm CROSSMAX PRO CARBON 27,5"

MOYEUX









4	N/A	HUB BODY
5	M40076	FRONT HUB 6903 BEARINGS
6	30870401	REAR AXLE KIT ITS4 135mm D6T/DCL 2012
7	99610601	ITS4 PAWLS KIT
8	35126001	ITS-4 FREEWHEEL BODY + SEAL 2013 (WITHOUT PAWLS)
8	99610701	ITS4 SEAL
9	35684101	ITS-4 FREEWHEEL BODY XD +SEAL 2013 (WITHOUT PAWLS)
10	30872201	FORK REST ITS-4 135mm REAR AXLE 2012
11	N/A	HUB BODY
12	V2371201	KIT REAR QRM AXLE 135-142mm/BOOST 148mm

TYRES

14	39243132	Pulse Pro 27,5" 2.25
14	39243121	Pulse Pro 27,5" 2.1

MAVIC Crossmax Pro Carbon 27.5

DELIVERED WITH

1 bottle of Mavic Sealant (355 466 01) 1	
BX601 quick releases (V24 503 01 frt, V24 504 01 rear) 1	
Front QR adapters (996 941 01 for MTB or B41 043 01 for road) 1	
Rear 12x142mm adapters for Instant Drive 360 (B49 896 01 for ID360 6T, B49 899 01 for ID360 CL) 1	
Rear 12x142mm adapters for ITS4 and TS2 (308 593 01 for ITS4, 329 650 01 for TS2) 1	
UST valve and accessories (129 838 01)	
Specific disc bolts (308 719 01) Pack of 6	
Tubeless rim tape	
Multifonction adjustment wrench (325 423 01) 1	
User guide	

COMPATIBILITY

Freewheel: Shimano/Sram, convertible to XD with optional driver body	
Front axle: convertible from 15mm thru axle to Quick Release with included adapters	
Rear axle: 12mm thru axle, convertible to Quick Release with optional adaptaters	

Specifications

RIMS

- **Material** : 100% Unidirectional carbon fiber
- **Drilling** : traditional
- **Valve hole diameter** : 6.5 mm
- **Tyre** : UST Tubeless and tubetype
- **Internal width** : 23 mm
- **ETRTO size 27.5"** : 584x23ss
- **ETRTO size 29"** : 622x23ss

Hookless profile

Use with Mavic Tubeless Tape

SPOKES

- **Material** : steel
- **Shape** : straight pull, bladed, double butted
- **Count** : 24 front and rear
- **Lacing** : front and rear crossed 2

WHEEL HUB

- **Front and rear bodies** : aluminum
- **Axle material** : aluminum
- Adjustable sealed cartridge bearings
- **Freewheel** : ITS-4 alloy

VERSIONS

- **Color** : Black only
- **Disc standard** : 6 Bolts only
- **Hub width** : Boost (front 110, rear 148) or Non-Boost (front 100, rear 135/142)
- Lefty Supermax

WHEEL WEIGHTS

Wheel weight
Weight Rear 27.5": 790
Weight Rear 29": 810