

ASTM CATEGORY 3 : offroad with jumps less than 61cm
Recommended weight limit : 120kg
Recommended tire sizes: 35 mm to 69 mm (1.4" to 2.7")

REFERENCES WHEELS

F70571	XAProCarb27.5FtBoostWTS	P83231	XAProCarb27.5PrWTS
F72111	XaPC27.5Ft15x110NTSMU Red	F56701	XAProCarbon27.5FtWTS

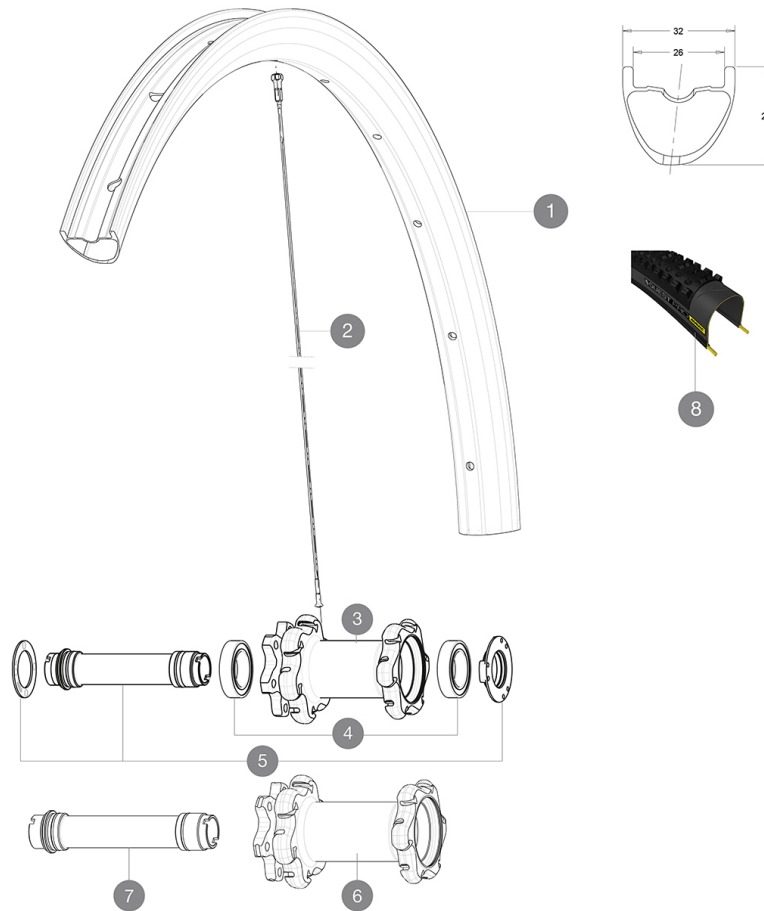

RIMS



Ø VALVE HOLE (MM): 6,5

1	V3220110	SET Front rim XA PRO CARBON 27,5"
---	----------	-----------------------------------

SPOKES

2	V2385001	KIT 12 FRONT + REAR NON-DRIVE SIDE BUTTED SPOKES 272mm XA PRO CARBON 27,5"
---	----------	----------------------------------------------------------------------------

MOYEUX





3	N/A	HUB BODY
4	99688501	BEARING KIT 9/15 D6T HUB
5	V2252301	MY16 FRONT AXLE ROAD DISC 9/12/15 INT
6	N/A	HUB BODY
7	V2370701	KIT FRONT QRM+ AXLE BOOST INTL 110mm

TYRES

8	39243324	Quest Pro 27,5x2.40
---	----------	---------------------

MAVIC XA Pro Carbon

DELIVERED WITH

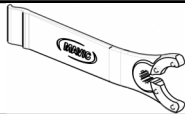
1 bottle of Mavic Sealant (355 466 01) 1	
BX601 quick releases (V24 503 01 frt, V24 504 01 rear) 1	
Front QR adapters (996 941 01 for MTB or B41 043 01 for road) 1	
Rear 12x142mm adapters for ITS4 and TS2 (308 593 01 for ITS4, 329 650 01 for TS2) 1	
UST valve and accessories (129 838 01)	
Tubeless rim tape	
Multifunction adjustment wrench (325 423 01) 1	
User guide	

COMPATIBILITY

Freewheel: Shimano/Sram, convertible to XD with optional driver body	
Front axle: convertible from 15mm thru axle to Quick Release with included adapters	
Rear axle: 12mm thru axle, convertible to Quick Release with included adapters	

Specifications

RIMS

- **Material** : 100% Unidirectional carbon fiber
 - **Drilling** : traditional
 - **Valve hole diameter** : 6.5 mm
 - **Tire** : UST Tubeless and tubetype
 - **Internal width** : 26 mm
 - **ETRTO size 27.5"** : 584x26ss
 - **ETRTO size 29"** : 622x26ss
- Hookless profile
Use with Mavic Tubeless Tape

SPOKES

- **Material** : steel
- **Shape** : straight pull, bladed, double butted
- **Count** : 24 front and rear
- **Lacing** : front and rear crossed 2

WHEEL HUB

- **Front and rear bodies** : aluminum
 - **Axle material** : aluminum
- Adjustable sealed cartridge bearings
- **Freewheel** : ITS-4 alloy

VERSIONS

- **Color** : Black only
- **Disc standard** : 6 Bolts only
- **Hub width** : Boost (front 110, rear 148) or Non-Boost (front 100, rear 135/142)

WHEEL WEIGHTS

Wheel weight
Weight Front 27.5": 715
Weight Front 29": 735